

Atık Su ve Drenaj
Dalgıç Pompaları

Waste Water and Drainage
Submersible Electropumps

GDP

GDP 50

GDP 80

GDP 100



SEPDRAIN®

www.seppump.eu

GDP Serisi - GDP Series

Malzeme Özellikleri (GDP SER S)

	Standart	Opsiyonel
1. Salyangoz	: Pik Döküm	Bronz
2. Fan	: Pik Döküm	Bronz
3. Motor Gövdesi	: Pik Döküm	Bronz
4. Motor Mili	: Paslanmaz Çelik (AISI 420)	Paslanmaz Çelik
5. Klemens Kapağı	: Pik Döküm	Bronz
6. Rulman	: 2Z Bilyalı	-
7. Mekanik Salmastra	: S C - S C	TuC - TuC
8. Cıva ve Somunlar	: Paslanmaz Çelik	-

Material Description (GDP SER S)

	Standard	Optional
1. Casing	: Cast Iron	: Bronze
2. Impeller	: Cast Iron	: Bronze
3. Motor Housing	: Cast Iron	: Bronze
4. Motor Shaft	: Stainless Steel (AISI 420)	: Satinless Steel (A)
5. Cable Cover	: Cast Iron	: Bronze
6. Bearing	: 2Z Ball Bearing	: -
7. Mechanical Seal	: S C - S C	: TuC - TuC
8. Bolt and Nuts	: Stainless Steel	: -

Teknik Özellikler (GDP 50-80-100)

Maksimum Parçacık Boyutu	: 35 mm - 85 mm
Maksimum Su Sıcaklığı	: 40 °C
Maksimum Özgül Ağırlık	: 1.2 g / cm ³
Maksimum Viskosite	: 1.5 x 10 ⁶
Motor İzolasyon Sınıfı	: F
Motor Koruma Sınıfı	: IP68

Technical Specifications (GDP 50-80-100)

Maximum Solid Diameter	: 35 mm - 85 mm
Maximum water Temp.	: 40 °C
Maximum Gravity	: 1.2 g / cm ³
Maximum Viscosity	: 1.5 x 10 ⁶
Motor Insulation Class	: F
Motor Protection	: IP68

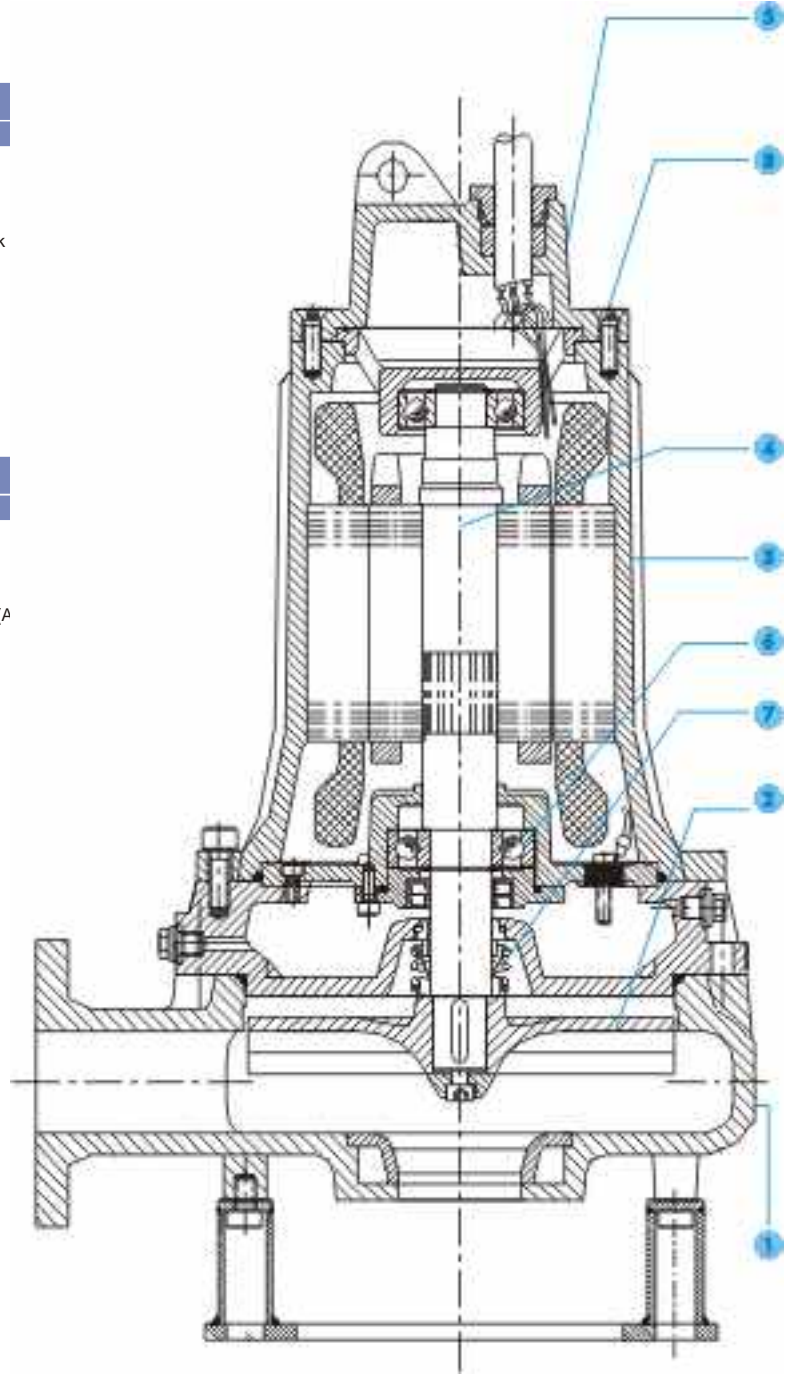

Kullanım Yerleri

- Kanalizasyon Suları
- Endüstriyel ve Evsel Atıklar
- Pis Sular
- Drenaj ları
- Ya mur Suları
- Arıtma Tesisleri
- Apartmanlar
- Oteller
- Hastaneler
- Tatil Köyleri

Application Fields

- Sewage Disposal
- Industrial Waste Water
- Domestic Waste Water
- Dirty Water
- Dewatering
- Rain Water
- Sewage Treatment Plants
- Apartments, Hotels
- Hospitals
- Holiday Villages

GDP-50 Serisi • GDP-50 Series

Performans Tablosu • Performance Tables

	Motor			Debi (m ³ /sa) • Capacity (m ³ /h)													Ambalaj Boyutu (mm) Packing Size (mm)	A ırlık (kg) Weight (kg)		
	HP	Kw	d/dk rpm	0	5	10	15	20	25	30	35	40	45	50	55	60				
Vortex Fanlı Vortex Impeller	50/200	5.5	4	2900	25	24	23	22	21	20	19	18	16	15				550 x 350 x 290	72	
	50/160	4	3		21	20	20	19	18	16	15	14	13						70	
	50/160	3	2.2		18	17	16	14	13	12	11	9.2							550 x 310 x 290	57
	50/160	2	1.5		14	13	12	11	10	8.7	7.3								54	
	50/200	2	1.5	1450	11	11	10	9.38	9.2	8.5	7.8	6.8							550 x 350 x 290	63
	50/200	1.5	1.1		9.4	9.0	8.5	8	7.3	6.4	5.5								61	
	50/200	1	0.75		7.8	7.3	6.7	6.0	5.3	4.3									60	
	50/160	0.75	0.55		6.7	5.9	5.2	4.2											550 x 310 x 290	60
Çift Kanatlı Double Blade	50/200	5.5	4	2900	30	27	26	21	23	22	21	21	19	18	16			550 x 350 x 290	72	
	50/200	4	3		25	23	21	20	19	18	17	16	15	14					70	
	50/160	3	2.2		19	18	17	16	15	14	12	11	9	8					550 x 310 x 290	57
	50/160	2	1.5		17	15	14	13	12	11	9	7.3	5.5						54	
	50/200	2	1.5	1450	13	11	10	9.6	9.1	8.6	7.9	6.9							550 x 350 x 290	63
	50/200	1.5	1.1		10	9	8.4	7.8	7.3	6.6	5.7								61	
	Parçalayıcı Grinder	50/200	5.5	4	2900	36	35	32	29	25	22								550 x 350 x 290	72
		50/200	4	3		30	28	25	22	19	16									70

GDP-80 Serisi - GDP-80 Series

Performans Tablosu • Performance Tables

	Motor			Debi (m ³ /sa) • Capacity (m ³ /h)													Ambalaj Boyutu (mm) Packing Size (mm)	A ırlık (kg) Weight (kg)		
	HP	Kw	d/dk rpm	0	5	10	15	20	25	30	35	40	45	50	55	60				
Vortex Fanlı Vortex Impeller	80/200	7.5	5.5	2900	21.5	21.0	20.5	19.9	19.2	18.5	17.7	16.8	15.9	14.8	13.7	12.6	11.4	650 x 370 x 310	87	
	80/200	5.5	4.0		19.2	18.4	17.7	16.8	16.0	15.0	14.0	13.0	11.9	10.8	9.6	8.4			84	
	80/200	3.0	2.2	1450	10.8	10.6	10.3	9.9	9.5	9.0	8.4	7.8	7.0	6.2	5.4	4.5		610 x 340 x 310	80	
	80/200	2.0	1.5		8.5	8.3	8.0	7.7	7.3	6.8	6.2	5.5	4.8	4.0					78	
	Çift Kanatlı Double Blade	80/200	7.5	5.5	2900	29.4	28.9	28.3	27.6	26.9	26.1	25.2	24.2	23.1	22.0	20.8	19.5	18.2	650 x 370 x 310	87
		80/200	5.5	4.0		23.5	22.9	22.3	21.6	20.8	20.0	19.2	18.3	17.3	16.4	15.3	14.3			84
80/200		4.0	3.0	19		19	18	18	17	16	15	14	13	12	11			81		
80/200		4.0	3.0	1450	14.6	14.1	13.5	12.9	12.3	11.7	11.0	10.4	9.7	8.9				650 x 370 x 310	81	
80/200		3.0	2.2		12.2	11.7	11.1	10.5	9.9	9.3	8.7	8.0	7.3						610 x 340 x 310	80
80/200		2.0	1.5		9.1	8.5	7.9	7.3	6.7	6.1	5.5	4.8								78

GDP-100 Serisi • GDP-100 Series

Performans Tablosu • Performance Tables

	Motor			Debi (m ³ /sa) • Capacity (m ³ /h)											Ambalaj Boyutu (mm) Packing Size (mm)	A ırlık (kg) Weight (kg)	
	HP	Kw	d/dk rpm	0	20	40	60	80	100	120	140	160	180	200			
Vortex Fanlı Vortex Impeller	100/250	15	11	1450	18,0	17,3	16,8	15,9	14,7	13,6	12,3	10,8	9,1	7,2	-	860 x 480 x 430	150
	100/250	10	7,5		15,0	14,4	13,5	12,5	11,4	10,1	8,5	7,0	5,4	-	-		146
Tek Kanatlı Single Blade	100/250	15	11	1450	21,0	19,2	18,0	16,9	16,1	15,2	14,3	13,3	12,0	10,9	9,0	860 x 480 x 430	155
	100/250	10	7,5		17,0	16,2	15,0	14,1	13,2	12,4	11,3	10,1	8,8	7,1	-		146
Çift Kanatlı Double Blade	100/250	15	11	2900	41,0	38,0	34,9	30,7	25,6	19,8	12,3	-	-	-	-	860 x 480 x 430	157
	100/250	10	7,5		30,0	27,5	24,0	20,5	15,7	9,3	-	-	-	-	-		145

GDP 50

Vortex - 2900 d/dk • Vortex - 2900 rpm

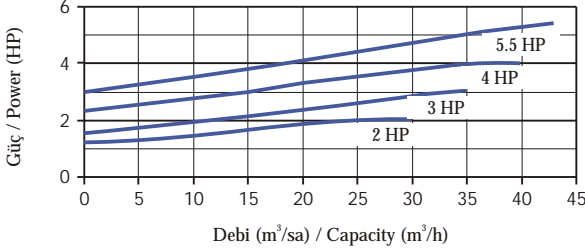
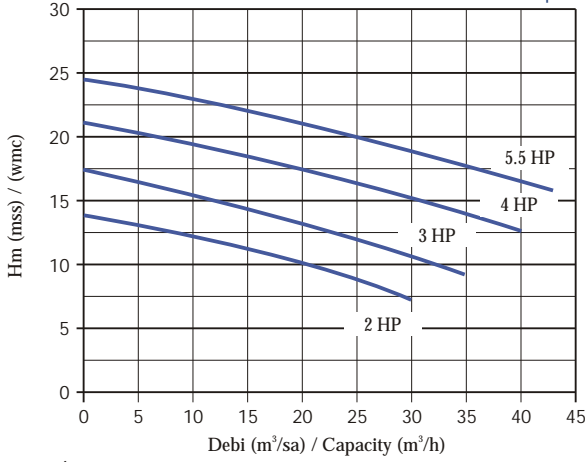

Maksimum Parçacık Boyutu / Max. Solid Diameter : 30 mm

GDP 50

Vortex - 1450 d/dk • Vortex - 1450 rpm

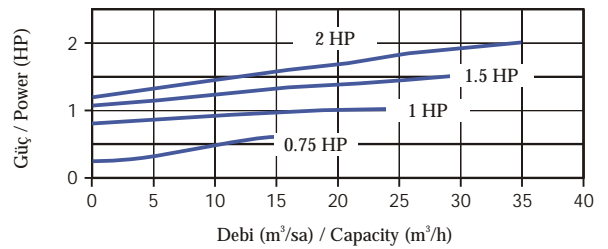
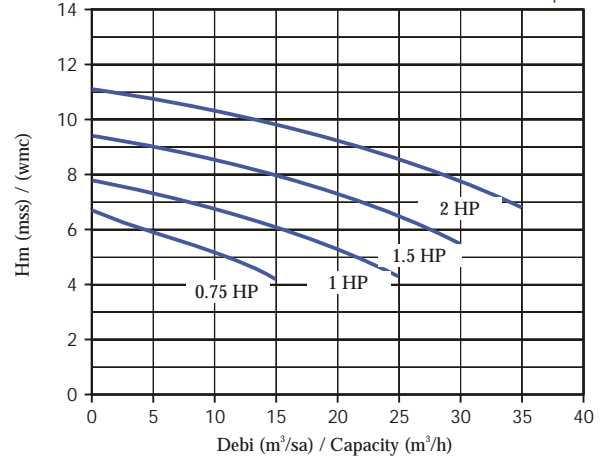

Maksimum Parçacık Boyutu / Max. Solid Diameter : 30 mm

GDP 50

Çift Kanatlı - 2900 d/dk • Double Blade - 2900 rpm

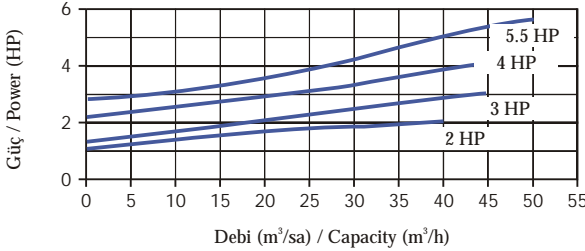
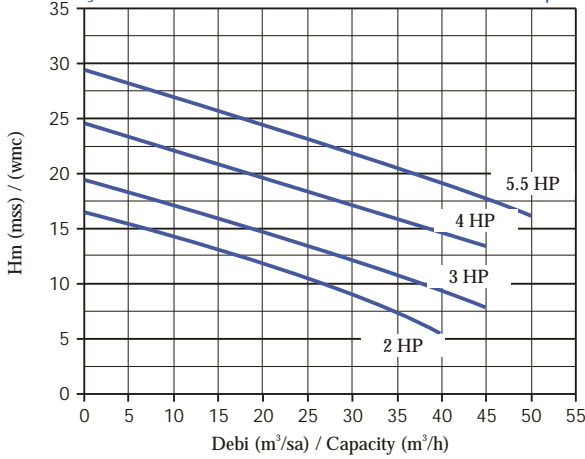

Maksimum Parçacık Boyutu / Max. Solid Diameter : 25 mm

GDP 50

Çift Kanatlı - 1450 d/dk • Double Blade - 1450 rpm

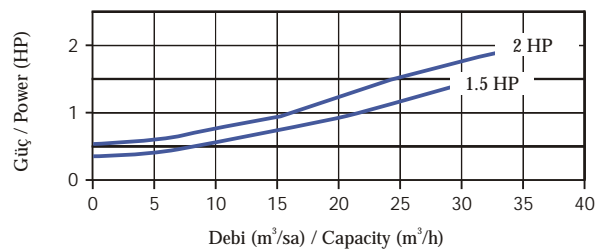
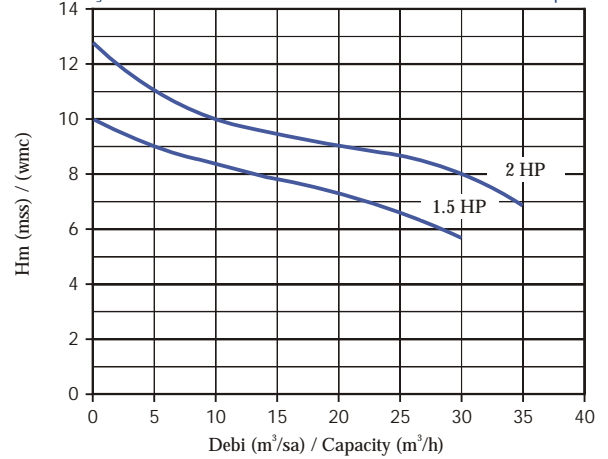

Maksimum Parçacık Boyutu / Max. Solid Diameter : 30 mm

GDP 50

Parçalayıcı Bıçaklı - 2900 d/dk • Grinder - 2900 rpm

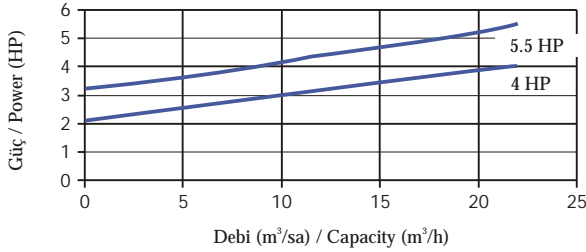
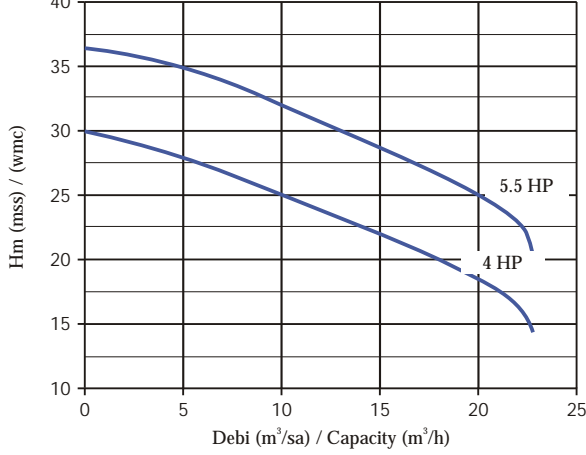

GDP 80

Vortex - 2900 d/dk • Vortex - 2900 rpm

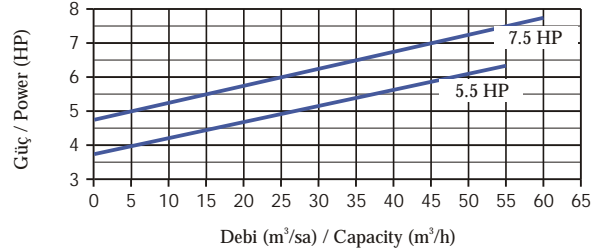
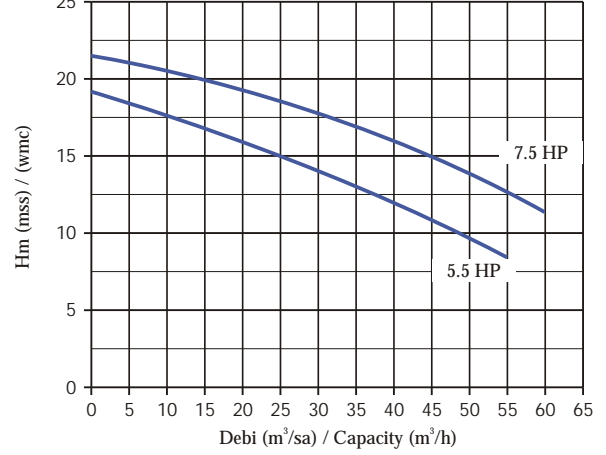

Maksimum Parçacık Boyutu / Max. Solid Diameter : 45 mm

GDP 80

Vortex - 1450 d/dk • Vortex - 1450 rpm

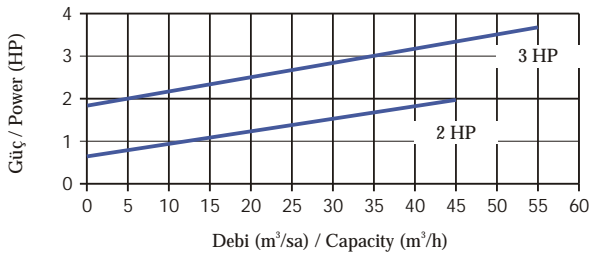
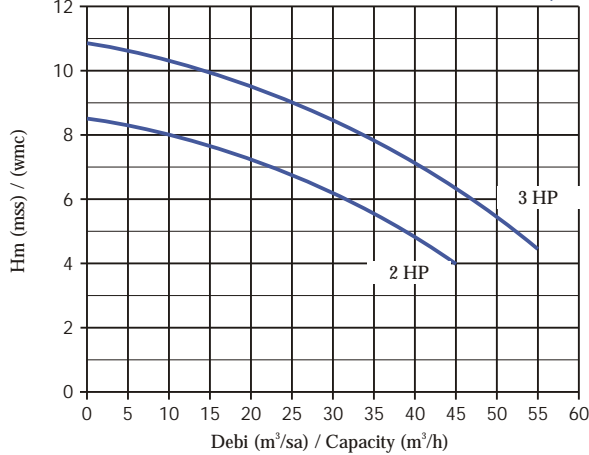

Maksimum Parçacık Boyutu / Max. Solid Diameter : 45 mm

GDP 80

Çift Kanatlı - 2900 d/dk • Double Blade - 2900 rpm

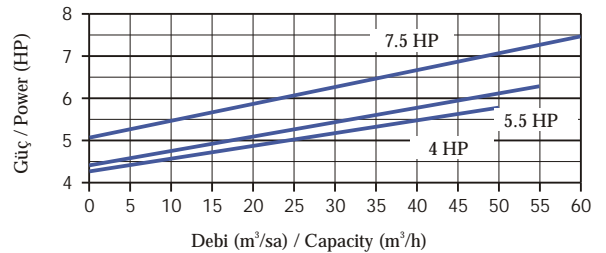
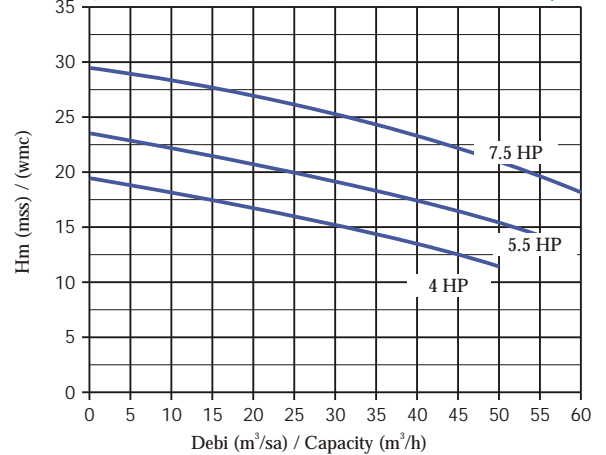

Maksimum Parçacık Boyutu / Max. Solid Diameter : 35 mm

GDP 80

Çift Kanatlı - 1450 d/dk • Double Blade - 1450 rpm

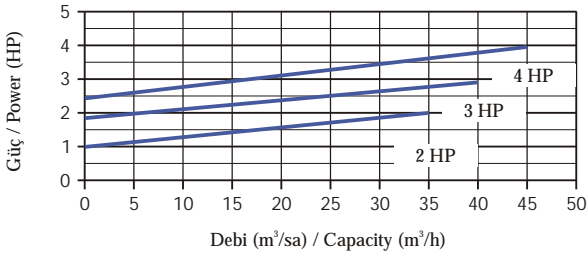
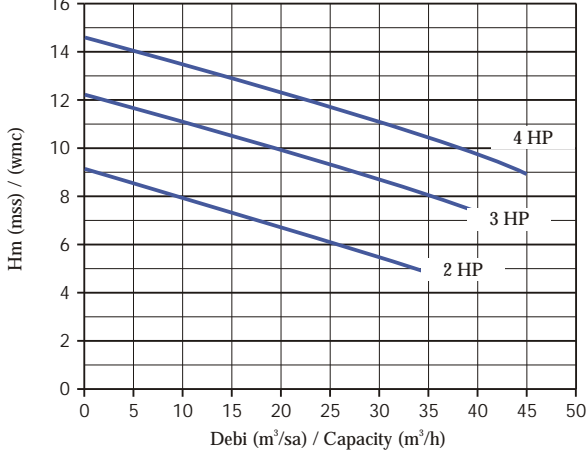

Maksimum Parçacık Boyutu / Max. Solid Diameter : 45 mm

GDP 100

Vortex - 1450 d/dk • Vortex - 1450 rpm

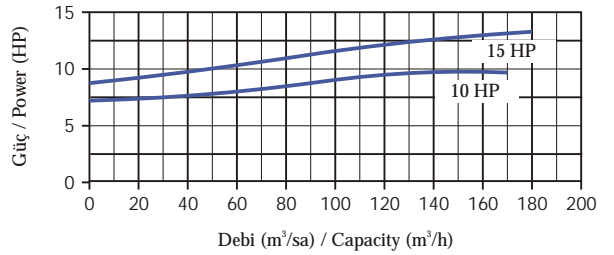
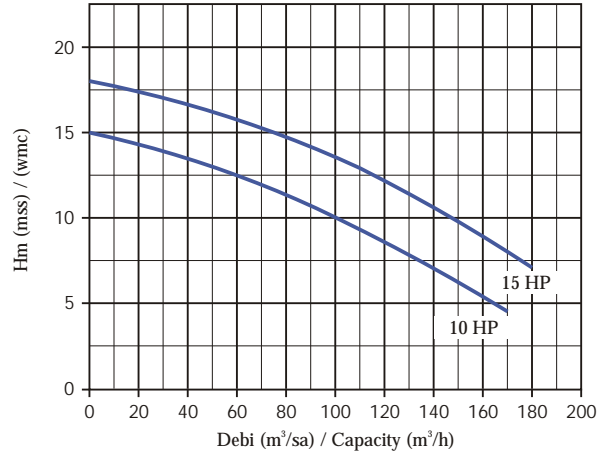

Maksimum Parçacık Boyutu / Max. Solid Diameter : 85 mm

GDP 100

Tek Kanat - 1450 d/dk • Single Blade - 1450 rpm

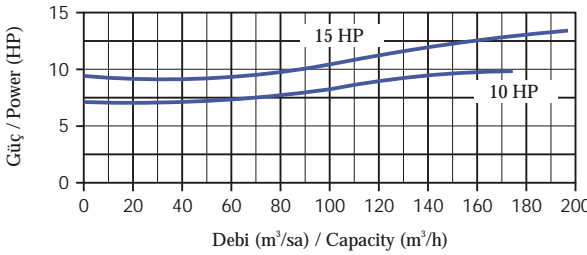
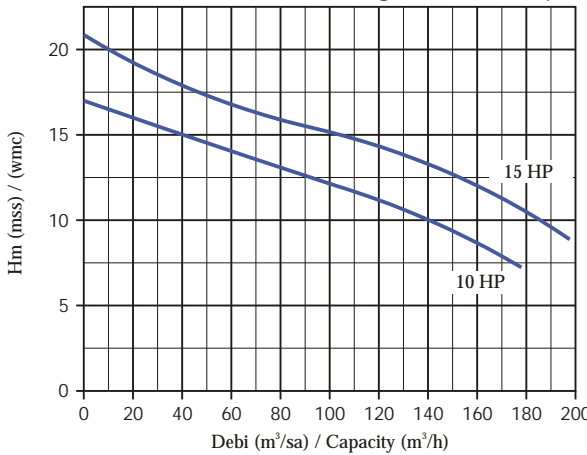

Maksimum Parçacık Boyutu / Max. Solid Diameter : 80 mm

GDP 100

Çift Kanatlı - 2900 d/dk • Double Blade - 2900 rpm

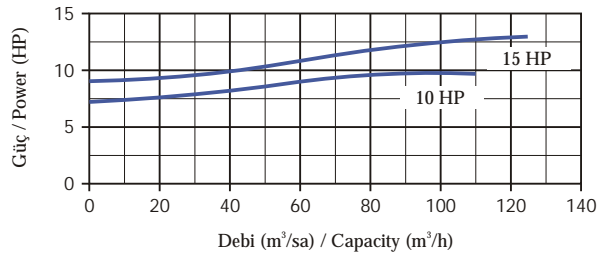
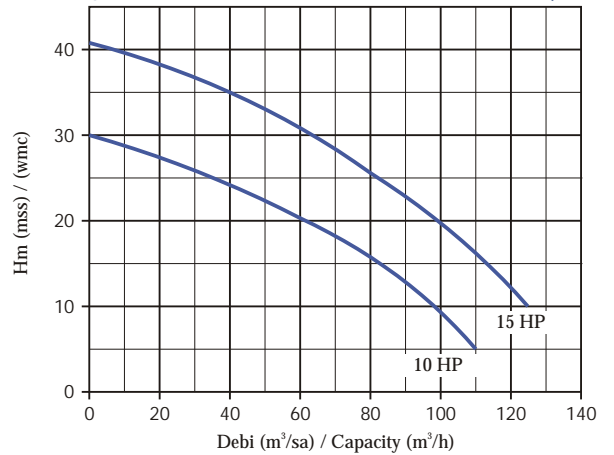

Maksimum Parçacık Boyutu / Max. Solid Diameter : 40 mm

SEP®

Pompa Sistemleri / Pump Systems

Dalgıç Pompa Motorları
Drenaj Pompaları
Hidrofor Pompalar
Dalgıç Pompalar
Dik Milli Pompalar
Endüstriyel Pompa Sistemleri
Özel Üretimler

Submersible Pump Motors
Waste Water and Drainage Pumps
Booster Sets
Submersible Pumps
Vertical Lineshaft Pumps
Industrial Pump Systems
Special Products



Gökşan Pompa Sanayi ve Ticaret Anonim Şirketi
Goksan Pump Industry INC.

Fabrika / Factory: 10014 Sk. No.7 Atatürk Organize Sanayi Bölgesi Çi li - zmir / TÜRK YE
Telefon / Phone: +90 (232) 376 74 28 (pbx) • Faks / Fax: +90 (232) 376 80 54
www.seppump.eu • www.goksan.com.tr • info@seppump.eu